

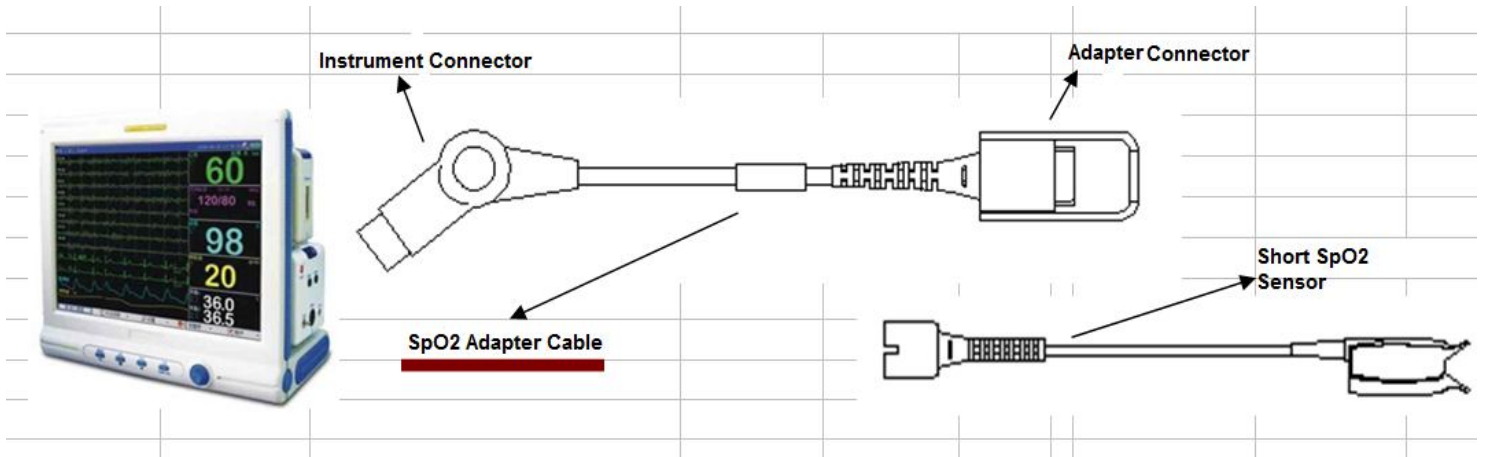

分体血氧转接线

SpO2 Adapter Cable



仪器端连接器 Instrument Connectors



血氧探头适配连接器 SPO2 Adapter Connector

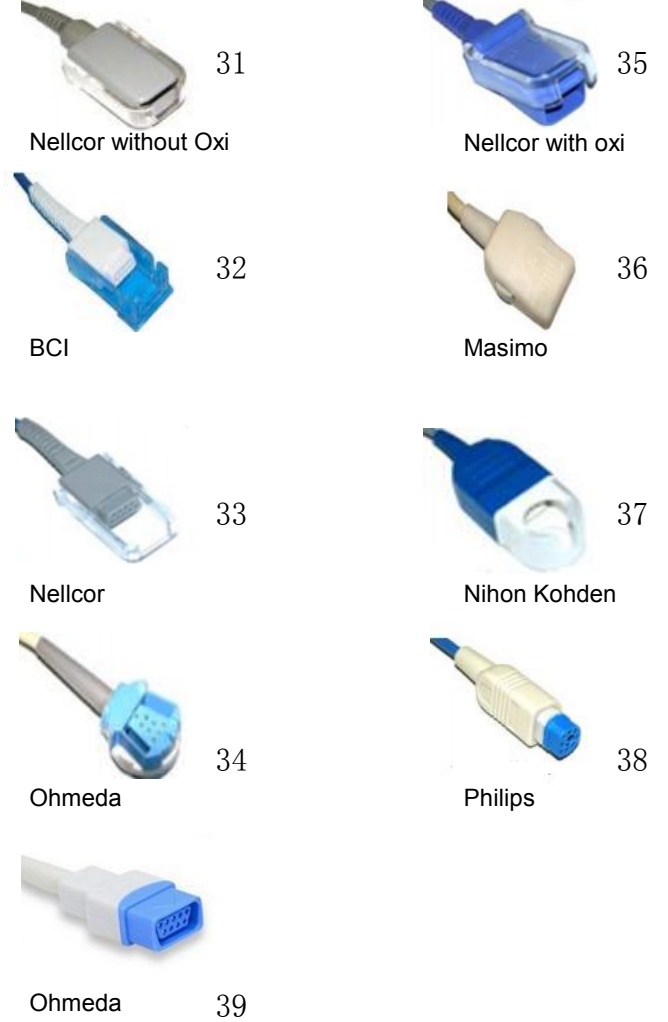



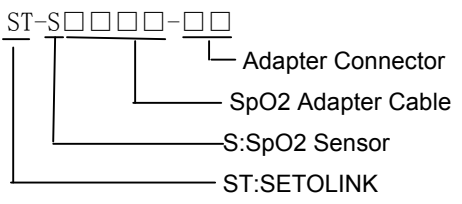

















Instruction for Model No:





分体血氧转接线

SpO2 Adapter Cable

兼容机型 Manufacturer	产品型号 Model	适配机型 OEM Model	产品描述 Product Description	连接器图示 Connector	适配插头 Adapter	价格 Price
BCI Biochem international	ST-S1111-32	Biochem International: 3401, 3304, 3303, 3302, 3301, 3300,	血氧转接线SPO2 CABLE: 连接器Connector:DB 9M TO DB9F 线缆CABLE: OD4.0 L=2.4M 适配于BCI短线血氧探头 Used for BCI Short spo2 sensor			
	ST-S1112-32	BCI:6100, 9100 Advisor, Autocorr, Torr, Mini Torr Plus	血氧转接线SPO2 CABLE: 连接器Connector:ST 7P TO DB9F 线缆CABLE: OD4.0 L=2.4M 适配于BCI短线血氧探头 Used for BCI Short spo2 sensor			
Bionet 韩国品牌	ST-S1113-33	BM3, BM3 Plus	血氧转接线SPO2 CABLE: 连接器Connector:Round 6PM TO DB9F 线缆CABLE: OD4.0 L=2.4M 适配于Bionet短线血氧探头 Used for Bionet Short spo2 sensor			
Bionet 韩国品牌	ST-S1114-33	BM3vet, BM3	血氧转接线SPO2 CABLE: 连接器Connector:ST 7PM TO DB9F 线缆CABLE: OD4.0 L=2.4M 适配于Bionet短线血氧探头 Used for Bionet Short spo2 sensor			
布鲁克 Bruker (ODAM)	ST-S1115-33	Bruker(Odam) ALL as dc-3002, 1H, M3	血氧转接线SPO2 CABLE: 连接器Connector:Round 12PM TO DB9F 线缆CABLE: OD4.0 L=2.4M 适配于Bruker短线血氧探头 Used for Bruker Short spo2 sensor			
BIOSYS 韩国品牌	ST-S1116-33	BPM300	血氧转接线SPO2 CABLE: 连接器Connector:ST 5PIN TO DB9F 线缆CABLE: OD4.0 L=2.4M 适配于Biosys短线血氧探头 Used for Biosys Short spo2 sensor			
CSI Criticare systems intemational	ST-S1117-32	CSI:506 Spot CSI 507SD, 503 Spot	血氧转接线SPO2 CABLE: 连接器Connector:DB 6PIN TO DB9F 线缆CABLE: OD4.0 L=2.4M 适配于CSI短线血氧探头 Used for CSI Short spo2 sensor			
CSI Criticare systems intemational	ST-S1118-32	CSI:Scholar, poet (602- 3A), 1100, 581, 508, 507, 507SD, 504, 503, 501 MINDRAY:500A, 508, 509	血氧转接线SPO2 CABLE: 连接器Connector:ST 5PM TO DB9F 线缆CABLE: OD4.0 L=2.4M 适配于CSI短线血氧探头 Used for CSI Short spo2 sensor			
DATASCOPE	ST-S1119-32	Datascope:Accusat Datascope:Accutorr 3 SAT Datascope:Accutorr 4 SAT Datascope:Accutorr Plus Passport (Database Spo2)	血氧转接线SPO2 CABLE: 连接器Connector:Round 8PM TO DB9F 线缆CABLE: OD4.0 L=2.4M 适配于Datascope短线血氧探头 Used for Datascope Short spo2 sensor			
德恩 DATEX	ST-S1120-33	Datex:AS/3, CS/3, CH/S, CH/2S CH- RS, CG/2S, Cardiocap 1, Cardiocap 11, Cardiocap 5, Capnomac Ultima , Light Monitor, M-Estpr, Oscar 11, OSP-200, Satlite Trans Plus, System 5, ULTS00	血氧转接线SPO2 CABLE: 连接器Connector:Round 10F TO DB9F 线缆CABLE: OD4.0 L=2.4M 适配于德恩短线血氧探头 Used for DATEX Short spo2 sensor			



分体血氧转接线

SpO2 Adapter Cable

兼容机型 Manufacturer	产品型号 Model	适配机型 OEM Model	产品描述 Product Description	连接器图示 Connector	适配插头 Adapter	价格 Price
海豚 DOLPHIN (OSI)	ST-S1121-32	DOLPHIN ONE OXIMETERS 原厂编号OEM NO:110	血氧转接线SPO2 CABLE: 连接器Connector:ST 14PM TO DB9F 线缆CABLE: OD4.0 L=2.4M 适配于Dolphin短线血氧探头 Used for Dolphin Short spo2 sensor			
德尔格 Drager	ST-S1122-33	Siemeds-Drager:SC6002XL, 7000 SC8000, SC9000XL	血氧转接线SPO2 CABLE: 连接器Connector:Round 7PM TO DB9F 线缆CABLE: OD4.0 L=2.4M 适配于Drager短线血氧探头 Used for Draeger Short spo2 sensor			
德尔格 Drager	ST-S1123-31	Drager Medical:Vitalert 1000, Cicero原厂编号OEM NO:M35370	血氧转接线SPO2 CABLE: 连接器Connector:ST 8PM TO DB9F 线缆CABLE: OD4.0 L=2.4M 适配于奈普特短线血氧探头 Adapted NELLCOR Short spo2 sensor			
GE-马葵 Marqutte NELLCOR Module	ST-S1124-31	GE Medisal Systems:Eagle GE Medical Systems:Dash GE Medical Systems:Solar GE Medical Systems:TRAM Modular X50SL Series 原厂编号OEM NO:E9004GE	血氧转接线SPO2 CABLE: 连接器Connector: 11PM TO DB9F 线缆CABLE: OD4.0 L=2.4M 适配于奈普特短线血氧探头 Adapted NELLCOR Short spo2 sensor			
GE-马葵 Marqutte Oximax Module	ST-S1125-35	GE Medical Information technology:Dash 2500	血氧转接线SPO2 CABLE: 连接器Connector: 11PM TO DB9F 线缆CABLE: OD4.0 L=2.4M 适配于奈普特短线血氧探头 Adapted oximax Short spo2 sensor			
GE-马葵 Marqutte MASIMO Module	ST-S1126-36	GE-Marqutte:Dash2000, 3000, 4000 Solar7000, 8000 Eagle1000, 3000, SMK, SMV	血氧转接线SPO2 CABLE: 连接器Connector:11PM TO MASIMO 6J 线缆CABLE: OD4.0 L=2.4M 适配于马西莫插片式血氧探头 Adapted MASIMO Insert spo2 sensor			
	ST-S1127-31	GE-Marqutte:Dash2000, 3000, 4000 Solar7000, 8000 Eagle1000, 3000, SMK, SMV	血氧转接线SPO2 CABLE: 连接器Connector:11PM TO DB9F 线缆CABLE: OD4.0 L=2.4M 适配于马西莫短线血氧探头 Adapted MASIMO Short spo2 sensor			
德恩-欧美达 DATEX-OHMEDA	ST-S1128-34	Sensor solutions for datex-Ohmeda S/5 FM Ports, Datex-ohmeda F-CU5 原厂编号OEM NO: OXY-ES3	血氧转接线SPO2 CABLE: 连接器Connector:11PIN TO OHMEDA 8Hole 线缆 CABLE: OD4.0 L=2.4M 适配于欧美达爪式短线血氧探头 Adapted OHMEDA spo2 sensor			
海力格 Hellige	ST-S1129-33	Servomed 4, Generation SCP844, 851, 852, SCS 804, SMK 151, 153 154 155-1, 156, 157, 181, 182 SMK 104T, 107, 111, 168, SMS 316, SMC108, SMV104 Servomed N4, Servomed, Serie SMU Cardioserv, Vicom SM, 511, 611, 612, 630 Serie SMK- 200, 210, 211, 230, 231, 240, 250, Pepita203, R204, 204R, 205, 205R	血氧转接线SPO2 CABLE: 连接器Connector:Round 10PM TO DB9F 线缆CABLE: OD4.0 L=2.4M 适配于奈普特短线血氧探头 Adapted NELLCOR Short spo2 sensor			



分体血氧转接线

SpO2 Adapter Cable

兼容机型 Manufacturer	产品型号 Model	适配机型 OEM Model	产品描述 Product Description	连接器图示 Connector	适配插头 Adapter	价格 Price
英威 INVIVO NELLCOR Module	ST-S1130-33	4500, 4500Plus, Millenia, Omega 1445, Omni-Trak TVS, Sat Scout 厂编号OEM NO: 9383	血氧转接线SPO2 CABLE: 连接器Connector:ST 7PM TO DB9F 线缆CABLE: OD4.0 L=2.4M 适配于奈普特短线血氧探头 Adapted NELLCOR Short spo2 sensor			
英威 INVIVO MASIMO Module	ST-S1131-36	Invivo M8, M12 and Escort M	血氧转接线SPO2 CABLE: 连接器Connector:ST 7PM TO MASIMO 6J 线缆CABLE: OD4.0 L=2.4M 适配于马西莫插片式血氧探头 Adapted MASIMO Insert spo2 sensor			
英威 INVIVO MASIMO Module	ST-S1132-31	Invivo M8, M12	血氧转接线SPO2 CABLE: 连接器Connector:ST 7PM TO DB9F 线缆CABLE: OD4.0 L=2.4M 适配于马西莫短线血氧探头 Adapted MASIMO Short spo2 sensor			
康强 KONTRON	ST-S1133-33	Kontron:7840, 7845 Kontron:Kolormon Kontron:Micromon Kontron:Minimon 7137 Kontron:Supemon Kontron:Trakmon	血氧转接线SPO2 CABLE: 连接器Connector:Round 12PM TO DB9F 线缆CABLE: OD4.0 L=2.4M 适配于奈普特短线血氧探头 Adapted NELLCOR Short spo2 sensor			
马西莫 MASIMO	ST-S1134-36	MAsimo ALL MDE:Escort11 OPT30:Prism GE Marquette: PRO1000, V300, INVIVO:T8 Schiller, ZPLL Datascope:Trio, Passport2	血氧转接线SPO2 CABLE: 连接器Connector:SCSI 14PF TO MASIMO 6J 线缆CABLE: OD4.0 L=2.4M 适配于马西莫插片式血氧探头 Adapted MASIMO Insert spo2 sensor			
马西莫 MASIMO	ST-S1135-31	MAsimo ALL MDE:Escort11 OPT30:Prism GE Marquette: PRO1000, V300, INVIVO:T8 Schiller, ZPLL Datascope:Trio, Passport2	血氧转接线SPO2 CABLE: 连接器Connector:SCSI 14PF TO DB9M 线缆CABLE: OD4.0 L=2.4M 适配于马西莫短线血氧探头 Adapted MASIMO Short spo2 sensor			
美克 MEK 韩国品牌	ST-S1136-33	MP1000 (NELLCOR Module) 奈普特模块	血氧转接线SPO2 CABLE: 连接器Connector:Round 8PM TO DB9F 线缆CABLE: OD4.0 L=2.4M 适配于nellcor短线血氧探头 Adapted NELLCOR Short spo2 sensor			
美克 MEK 韩国品牌	ST-S1137-32	REF: MIS3AH-1 MEK ICS: MP-1000NT TYPE: MEK (CSI Module) (CSI模块)	血氧转接线SPO2 CABLE: 连接器Connector:Round 8PM TO DB9F 线缆CABLE: OD4.0 L=2.4M 适配于MEK短线血氧探头 Adapted MEK Short spo2 sensor			
美克 MEK 韩国品牌	ST-S1138-32	MP-100, MP110, MP400, MP500, MP600, MP1000 (CSI Module) (CSI模块)	血氧转接线SPO2 CABLE: 连接器Connector:DB 6PM TO DB9F 线缆CABLE: OD4.0 L=2.4M 适配于MEK短线血氧探头 Adapted MEK Short spo2 sensor			
迈瑞 MINDRAY	ST-S1139-35	VS800 (Mindray module) MEC-1000 PM7000, 8000, 9000, 6201 Marketing:SFDA, CE, FDA, 原厂编号OEM NO:0010-20-42594	血氧转接线SPO2 CABLE: 连接器Connector:ST 6PM TO DB9F 线缆CABLE: OD4.0 L=2.4M 适配于奈普特短线血氧探头 Adapted NELLCOR Short spo2 sensor			



分体血氧转接线

SpO2 Adapter Cable

兼容机型 Manufacturer	产品型号 Model	适配机型 OEM Model	产品描述 Product Description	连接器图示 Connector	适配插头 Adapter	价格 Price
迈瑞 MINDRAY MASIMO Module	ST-S1140-31	PM-9000, 9100, 9200 (PM-6201, 7000, 8000, 9000, M1KO, M2KO before 2006) 原厂编号OEM NO:0010-30-42602	血氧转接线SPO2 CABLE: 连接器Connector:ST 6PM TO DB9F 线缆CABLE: OD4.0 L=2.4M 适配于MASIMO短线血氧探头 Adapted MASIMO Short spo2 sensor			
	ST-S1141-36	PM-9000, 9100, 9200 (PM-6201, 7000, 8000, 9000, M1KO, M2KO before 2006)	血氧转接线SPO2 CABLE: 连接器Connector:ST 6PM TO MASIMO 6J 线缆CABLE: OD4.0 L=2.4M 适配于马西莫插片式血氧探头 Adapted MASIMO Insert spo2 sensor			
	ST-S1142-31	PM9000express (Masimo), PM8002, 9201, (6201, 7000, 8000, M1KO, M2KO, Since 2006), T8 原厂编号OEM NO:0010-30-42625	血氧转接线SPO2 CABLE: 连接器Connector:ST 6PM TO DB9F 线缆CABLE: OD4.0 L=2.4M 适配于马西莫短线血氧探头 Adapted MASIMO Short spo2 sensor			
	ST-S1143-36	PM9000express (Masimo), PM8002, 9201, (6201, 7000, 8000, M1KO, M2KO, Since 2006), T8 原厂编号OEM NO:0010-30-42625	血氧转接线SPO2 CABLE: 连接器Connector:ST 6PM TO MASIMO 6J 线缆CABLE: OD4.0 L=2.4M 适配于马西莫插片式血氧探头 Adapted MASIMO Insert spo2 sensor			
迈瑞 MINDRAY NELLCOR Module	ST-S1144-31	PM6800 DM6, DM7, Bene View T5 (迈瑞血氧板MINDRAY Module) 原厂编号OEM NO:0010-20-42710	血氧转接线SPO2 CABLE: 连接器Connector:Round 7PM TO DB9F 线缆CABLE: OD4.0 L=2.4M 适配于奈普特短线血氧探头 Adapted NELLCOR Short spo2 sensor			
迈瑞 MINDRAY MASIMO Module	ST-S1145-31	PM-6800 (MASIMO Module) BeneView T5, T6, T8病人监护仪 Patient Monitor	血氧转接线SPO2 CABLE: 连接器Connector:Round 7PM TO DB9F 线缆CABLE: OD4.0 L=2.4M 适配于马西莫短线血氧探头 Adapted MASIMO Short spo2 sensor			
	ST-S1146-36	PM-6800 (MASIMO Module) BeneView T5, T6, T8病人监护仪 Patient Monitor	血氧转接线SPO2 CABLE: 连接器Connector: Round 7PM TOMASIMO 6J CABLE: OD4.0 L=2.4M 适配于马西莫插片式血氧探头 Adapted MASIMO Insert spo2 sensor			
迈瑞 MINDRAY	ST-S1147-35	迈瑞Mindray: PM-5000, 6000, 8100 原厂编号OEM NO: 0010-30-42737	血氧转接线SPO2 CABLE: 连接器Connector:Round 12PM TO DB9F 线缆CABLE: OD4.0 L=2.4M 适配于奈普特短线血氧探头 Adapted NELLCOR Short spo2 sensor			
迈瑞 MINDRAY MASIMO Module	ST-S1148-31	迈瑞Mindray: PM-5000, 6000 原厂编号OEM NO: 0010-30-12452	血氧转接线SPO2 CABLE: 连接器Connector:Round 12PIN TO DB9M 线缆CABLE: OD4.0 L=2.4M 适配于马西莫短线血氧探头 Adapted MASIMO Short spo2 sensor			
	ST-S1149-36		血氧转接线SPO2 CABLE: 连接器Connector:Round 12PIN TO MASIMO 6J 线缆CABLE: OD4.0 L=2.4M 适配于马西莫插片式血氧探头 Adapted MASIMO Insert spo2 sensor			



分体血氧转接线

SpO2 Adapter Cable

兼容机型 Manufacturer	产品型号 Model	适配机型 OEM Model	产品描述 Product Description	连接器图示 Connector	适配插头 Adapter	价格 Price
日本光电 NIHON KOHDEN	ST-S1150-33	AL-800PA Module, BSM-1101 Life scope EC, BSM-2101, 2102 Lifescop e L, BSM-3101 Lifescope LC, BSM-7100, 7200 Life scope 8, BSM-8200, 8201 Lifescope 12, DSM-8301, 8302 Lifescope 9, BSM-8800	血氧转接线SPO2 CABLE: 连接器Connector:Round 10PM TO DB9F 线缆CABLE: OD4.0 L=2.4M 适配于奈普特短线血氧探头 Adapted NELLCOR Short spo2 sensor			
	ST-S1151-37	Bedside monitor:BSM-4101, 4103 4111, 4113 Life scope P, BSM-5105, 5135, Life scope A, BSM-2351, 2353 Life scope L, BSM-2301, 2303 Life scope I 原厂编号OEM NO:JL-900P	血氧转接线SPO2 CABLE: 连接器Connector:14PM TO DB9F 线缆CABLE: OD4.0 L=2.4M 适配于日本光电短线血氧探头 Adapted Nihon Kohden Short spo2			
燕牌 NONIN	ST-S1152-33	8600 series 8500, 8600, 8700, 8800 9600, 9700	血氧转接线SPO2 CABLE: 连接器Connector:Square 8hole TO DB9M 线缆CABLE: OD4.0 L=2.4M 适配于燕牌短线血氧探头 Adapted NONIN Short spo2 sensor			
	ST-S1153-33	8604, 8604D	血氧转接线SPO2 CABLE: 连接器Connector:ST 6PM TO DB9F 线缆CABLE: OD4.0 L=2.4M 适配于燕牌插片式血氧探头 Adapted NONIN Insert spo2 sensor			
NELLCOR	ST-S1154-33	DATASCOPE:Accutorr Plus (NELLCOR)NPB-290, NPB-295, N-390N-395, N-3000, N-6000 Nihon Konden:BSM-4104A BSM-4114A, COLIN, BP88, BP306 原厂编号OEM NO:SCP-10	血氧转接线SPO2 CABLE: 连接器Connector:SCSI 14PF TO DB9F 线缆CABLE: OD4.0 L=2.4M 适配于奈普特短线血氧探头 Adapted NELLCOR Short spo2 sensor			
	ST-S1155-35	NELLCOR :N550, N595 GE:Dinamap PRO(W/OXI)Schiller 原厂编号OEM NO:DOC-10	血氧转接线SPO2 CABLE: 连接器Connector:AMP 14PF TO DB9F 线缆CABLE: OD4.0 L=2.4M 适配于奈普特短线血氧探头 Adapted NELLCOR Short spo2 sensor			
	ST-S1156-33	Nellcor:N100, N200, N180, N-20, NPB-40, NPB-75 Datascope:Expert, Passport GE medical:Corometrics NONIN:8500, 8604 原厂编号OEM NO: EC-8	血氧转接线SPO2 CABLE: 连接器Connector:DB 7PM TO DB9F 线缆CABLE: OD4.0 L=2.4M 适配于奈普特短线血氧探头 Adapted NELLCOR Short spo2 sensor			
	ST-S1157-35	ALL Nellcor & Nellcor equipped OEM monitors not listed above 飞利浦Philips:Viridia A3 原厂编号OEM NO:DEC-8	血氧转接线SPO2 CABLE: 连接器Connector:DB 9PM TO DB9F 线缆CABLE: OD4.0 L=2.4M 适配于奈普特短线血氧探头 Adapted NELLCOR Short spo2 sensor			
	ST-S1158-00	NELLCOR :N550, N595 GE:Dinamap PRO(W/OXI)Schiller	血氧转接头Oxygen adapter: 连接器Connector:DB 9PM TO DB9F OXIMAX转接头OXIMAX Adapter plugs 适配于奈普特短线血氧探头 Adapted NELLCOR Short spo2 sensor			
	ST-S1159-33	Novamatrix: 505, 510, 511, 515B, 515C, 520, 7000, 7100, Oxypleth 太空:SpaceLabs:93051D, 93051G, 90465, 90466, 90467, 90489, 90651-07, 90651-08, 90419-01, 90651A-07	血氧转接线SPO2 CABLE: 连接器Connector:HYP 6PM TO DB9F 线缆CABLE: OD4.0 L=2.4M 适配于诺医短线血氧探头 Adapted NOVAMETRIX Insert spo2 sensor			



分体血氧转接线

SpO2 Adapter Cable

兼容机型 Manufacturer	产品型号 Model	适配机型 OEM Model	产品描述 Product Description	连接器图示 Connector	适配插头 Adapter	价格 Price
欧美达 OHMEDA	ST-S1160-34	Suitable for Datex-Ohmeda: Ohmeda: 3700, 3710, 3770, 3775, Biox3760, 3800xiCap, 4700 Oxicap 5250RGM, Rascal 11, GE Medical Systems, Corometrics511, Mennen: Horizon XL (Ohmeda SPO2)	血氧转接线SPO2 CABLE: 连接器Connector:HYP 7PM TO OHMEDA 8Hole 线缆CABLE: OD4.0 L=2.4M 适配于欧美达8针短线血氧探头 Adapted OHMEDA Short spo2 sensor			
	ST-S1161-32	Suitable for Datex-Ohmeda: Ohmeda: 3700, 3710, 3770, 3775, Biox3760, 3800xiCap, 4700 Oxicap 5250RGM, Rascal 11, GE Medical Systems, Corometrics511, Mennen: Horizon XL (Ohmeda SPO2)	血氧转接线SPO2 CABLE: 连接器Connector:HYP 7PM TO DB9F 线缆CABLE: OD4.0 L=2.4M/8ft 适配于OHMEDA7针短线血氧探头 Adapted OHMEDA 7PIN Short spo2			
通用-欧美达 GE-OHMEDA	ST-S1162-34	Sensor solutions for GE ohmeda trusat™ Pulse Oximeter	血氧转接线SPO2 CABLE: 连接器Connector:Square 9PIN TO OHMEDA 8Hole 线缆CABLE: OD4.0 L=2.4M/8ft 适配于欧美达8针短线血氧探头 Adapted OHMEDA Short spo2 sensor			
伯斯特 PACE TECH	ST-S1163-32	Generra: 710, 200, 300, 400, 810, 530 PACE TECH: Modell 520 All W/black face (except Vitalmax 800w/Nellcor@ SPO2)	血氧转接线SPO2 CABLE: 连接器Connector:MINI 5PF TO DB9F 线缆CABLE: OD4.0 L=2.4M/8ft 适配于BCI短线血氧探头 Adapted BCI Short spo2 sensor			
将军 General	ST-S1164-32	General	血氧转接线SPO2 CABLE: 连接器Connector:ST 7PIN TO DB9F 线缆CABLE: OD4.0 L=2.4M/8ft 适配于BCI短线血氧探头 Adapted BCI Short spo2 sensor			
飞利浦 PHILIPS	ST-S1165-38	Philips Medical: M2601A, M3000A, M3500 B, M4735A, MRx, SureSigns VS2, VS3.	血氧转接线SPO2 CABLE: 连接器Connector:D Shape 8PM TO D Shape 8 Hole 线缆CABLE: OD4.0 L=2.4M/8ft 适配于飞利浦短线血氧探头 Adapted Philips Short spo2 sensor			
飞利浦 PHILIPS	ST-S1166-31	Philips Medical: Heartstream XL, Intelliview MP70, M2601A, M3000A, M3500B, M4735A, M1020B, M3000A/M3001A MMS, M3002A MMS X2, M8102A MP2, M8105A MP5, SureSigns VS2, VS3.	血氧转接线SPO2 CABLE: 连接器Connector: D Shape 8PM TO DB9F 线缆CABLE: OD4.0 L=2.4M 适配于奈普特短线血氧探头 Adapted NELLCOR Short spo2 sensor			
	ST-S1167-38	PHILIPS: 78352A, 78352C, 78354A, 78354C, 78834C M1020A, M1025A, M1025B, M1205A M1350B, M1722A, M1722B, M1723A, M1723B, M2475B, V24, V24E	血氧转接线SPO2 CABLE: 连接器Connector:Round 12PM TO D Shape 8Hole 线缆CABLE: OD4.0 L=2.4M 适配于飞利浦短线血氧探头 Adapted Philips Short spo2 sensor			
	ST-S1168-31	PHILIPS: 78352A, 78352C, 78354A, 78354C, 78834C M1020A, M1025A, M1025B, M1205A M1350B, M1722A, M1722B, M1723A, M1723B, M2475B, V24, V24E	血氧转接线SPO2 CABLE: 连接器Connector:Round 12PM TO DB9M 线缆CABLE: OD4.0 L=2.4M 适配于奈普特短线血氧探头 Adapted NELLCOR Short spo2 sensor			
丹麦阿替玛 S&W ARTEMA	ST-S1169-33	S&w(Diascope G2)Patient Monitor, Diacopel, 2, 3 厂编号OEM NO:SL033057	血氧转接线SPO2 CABLE: 连接器Connector:Round 10F TO DB9F 线缆CABLE: OD4.0 L=2.4M 适配于奈普特短线血氧探头 Adapted NELLCOR Short spo2 sensor			



分体血氧转接线





SpO2 Adapter Cable

兼容机型 Manufacturer	产品型号 Model	适配机型 OEM Model	产品描述 Product Description	连接器图示 Connector	适配插头 Adapter	价格 Price
席勒 SCHILLER MASIMO Module	ST-S1170-31	Argus pro, argus 1CM	血氧转接线SPO2 CABLE: 连接器Connector:Round 7PM TO DB9F 线缆CABLE: OD4.0 L=2.4M 适配于马西莫短线血氧探头 Adapted MASIMO Short spo2 sensor			
	ST-S1171-36		血氧转接线SPO2 CABLE: 连接器Connector:Round 7PM TO MASIMO 6J 线缆CABLE: OD4.0 L=2.4M 适配于马西莫插片式血氧探头 Adapted MASIMO Insert spo2 sensor			
席勒 SCHILLER NELLCOR Module	ST-S1172-33	Schiller Argus TM-7	血氧转接线SPO2 CABLE: 连接器Connector:Round 7PM TO DB9F 线缆CABLE: OD4.0 L=2.4M 适配于奈普特短线血氧探头 Adapted NELLCOR Short spo2 sensor			
SIMED (Baxter)	ST-S1173-33	SIMED: S-50 SIMED: S-100 SIMED: S-100E 原厂编号OEM NO: 600015	血氧转接线SPO2 CABLE: 连接器Connector:ST 6PM TO DB9F 线缆CABLE: OD4.0 L=2.4M/8ft 适配于燕牌插片式血氧探头 Adapted NONIN Insert spo2 sensor			
西门子 SIEMENS	ST-S1174-33	Siemens medical: Sirecust 700 Sirecust 630 Sirem SPO2 Module	血氧转接线SPO2 CABLE: 连接器Connector:Round 10PM TO DB9F 线缆CABLE: OD4.0 L=2.4M/8ft 适配于奈普特短线血氧探头 Adapted NELLCOR Short spo2 sensor			
太空 Spacelabs	ST-S1175-33	Spacelabs Medical:90351-0/6;90465,90466,90489, 90651A-08,90651-A,IM77,90308,PC Scout 原厂编号OEM NO: 700-0020-00	血氧转接线SPO2 CABLE: 连接器Connector:Round 7PM TO DB9F 线缆CABLE: OD4.0 L=2.4M/8ft 适配于奈普特短线血氧探头 Adapted NELLCOR Short spo2 sensor			
太空 Spacelabs	ST-S1176-33	SPacelabs Medical: 1050,1600,1700,90369,90469, 90469 Ultraview 原厂编号OEM NO:700-0030-00	血氧转接线SPO2 CABLE: 连接器Connector: D Shape 8PM TO DB9F 线缆CABLE: OD4.0 L=2.4M 适配于奈普特短线血氧探头 Adapted NELLCOR Short spo2 sensor			
科曼 COMEN OLIMAX Module	ST-S1177-35		血氧转接线SPO2 CABLE: 连接器Connector:LEMO 8PIN TO DB9M 线缆CABLE: OD4.0 L=2.4M 适配于奈普特短线血氧探头 Adapted NELLCOR Short spo2 sensor			
金科威 GOLDWAY	ST-S1178-33		血氧转接线SPO2 CABLE: 连接器Connector:Round 12PIN TO DB9M 线缆CABLE: OD4.0 L=2.4M 适配于奈普特短线血氧探头 Adapted NELLCOR Short spo2 sensor			
宝莱特 Biolight	ST-S1179-33	宝莱特Biolight: M9500 A系列: AnyView A3, AnyView A5, AnyView A8 AnyView A6	血氧转接线SPO2 CABLE: 连接器Connector:Round 12PI8N TO DB9M 线缆CABLE: OD4.0 L=2.4M 适配于马西莫插片式血氧探头 Adapted MASIMO Insert spo2 sensor			



分体血氧转接线

SpO2 Adapter Cable

兼容机型 Manufacturer	产品型号 Model	适配机型 OEM Model	产品描述 Product Description	连接器图示 Connector	适配插头 Adapter	价格 Price
DATEX OHMEDA	ST-S1180-39	Datex-Ohmeda TruSignal SpO2 TS-N3 adapter cable	血氧转接线SPO2 CABLE: 连接器Connector:Round 10PF TO DB9F 线缆CABLE: OD4.0 L=2.4M			
DATEX OHMEDA	ST-S1181-39	Compatible Datex-Ohmeda TruSignal SpO2 TS-H3 Adapter Cable	血氧转接线SPO2 CABLE: 连接器Connector:HYP 7PM TO DB9F 线缆CABLE: OD4.0 L=2.4M			
DATEX OHMEDA	ST-S1182-39	Compatible Datex-Ohmeda TruSat for TruSignal TS-M3 adapter cable.	血氧转接线SPO2 CABLE: 连接器Connector:7PM TO DB9F 线缆CABLE: OD4.0 L=2.4M	